

Technical Specifications

EIGER R 1M Detector Systems

Document Version v1.3.2



CONTENT

CONTENT	i
DOCUMENT HISTORY	ii
Current Document	ii
Changes	ii
1 GENERAL INFORMATION	1
1.1 Contact and Support	1
1.2 Explanation of Symbols	1
1.3 Warranty Information	2
1.4 Disclaimer	2
2 USE OF THE EIGER R 1M	3
2.1 Product Return and Recycling	3
3 TECHNICAL SPECIFICATIONS	4
3.1 Specifications	4
3.1.1 Quantum Efficiency	4
3.1.2 Detector	4
3.1.3 Power Supply Unit	5
3.1.4 Detector Control Unit	6
3.1.5 Thermal Stabilization Unit	6
3.2 Ratings	6
3.2.1 Detector	6
3.2.2 Power Supply Unit	7
3.2.3 Detector Control Unit	7
3.2.4 Thermal Stabilization Unit	7
3.3 Ambient Conditions	8
4 DETECTOR DIMENSIONS AND CONNECTORS	9
4.1 EIGER R 1M Detector	9
4.1.1 Technical Drawing	9
4.1.2 Front Side of the Detector	10
4.1.3 Back Side of the Detector	11
4.1.4 Status LEDs	12
4.1.5 Connectors and Connecting Cables/Pipes	12
4.2 Detector Control Unit	13
4.2.1 Configuration	13
4.2.2 Connectors	15
4.3 Thermal Stabilization Unit	15
4.3.1 In-Vacuum Operation	16
5 INSTALLING THE DETECTOR SYSTEM	18
5.1 Transport Considerations	18
5.2 Mounting	18
5.2.1 Mounting from Above	18
5.2.2 Mounting from Below	19
5.3 Grounding of the Detector	19
5.4 Connection to Dry Air or Nitrogen	20
5.4.1 In-Vacuum Use	20
5.5 Connection to Thermal Stabilization Unit	20
5.6 Mounting the Detector Control Unit	21
6 TEMPERATURE AND HUMIDITY CONTROL	22

7	OPERATION PROCEDURE	23
7.1	Getting Started	23
7.2	Startup Procedure	23
7.3	Turning Off the Detector	23
7.4	Vacuum Operation	24
	7.4.1 Ambient Conditions for In-Vacuum Use	24
	7.4.2 Operation Procedure In-Vacuum	24
7.5	Storing the Detector	25
7.6	Cleaning and Maintenance	25
8	TROUBLESHOOTING	26

DOCUMENT HISTORY

Current Document

Table 1: Current Version of this Document

Version	Date	Status	Prepared	Checked	Released
v1.3.2	2018-05-29	release	AM, DJ, LW	SB, MM	SB

Changes

Table 2: Changes to this Document

Version	Date	Changes
v1.0.0	2017-04-09	First Release.
v1.2.0	2017-09-04	EIGER2 Integration.
v1.3.2	2017-09-04	PILATUS3 and EIGER2 API Documentation integration.

1. GENERAL INFORMATION

1.1. Contact and Support





Address: DECTRIS Ltd.
 Taefernweg 1
 5405 Baden-Daettwil
 Switzerland

Phone: +41 56 500 21 02
 Fax: +41 56 500 21 01

Homepage: <http://www.dectris.com/>
 Email: support@dectris.com

Should you have questions concerning the system or its use, please contact us via telephone, mail or fax.

1.2. Explanation of Symbols

Danger	#0
	Danger blocks are used to indicate immediate danger or risk to personnel or equipment.
Warning	#0
	Warning blocks are used to indicate danger or risk to personnel or equipment.
Caution	#0
	Caution blocks are used to indicate danger or risk to equipment.
Information	#0
	Information blocks are used to highlight important information.

1.3. Warranty Information

Caution

#1



Do not ship the system back before you receive the necessary transport and shipping information.

1.4. Disclaimer

DECTRIS has carefully compiled the contents of this manual according to the current state of knowledge. Damage and warranty claims arising from missing or incorrect data are excluded.

DECTRIS bears no responsibility or liability for damage of any kind, also for indirect or consequential damage resulting from the use of this system.

DECTRIS is the sole owner of all user rights related to the contents of the manual (in particular information, images or materials), unless otherwise indicated. Without the written permission of DECTRIS it is prohibited to integrate the protected contents in this publication into other programs or other websites or to use them by any other means.

DECTRIS reserves the right, at its own discretion and without liability or prior notice, to modify and/or discontinue this publication in whole or in part at any time, and is not obliged to update the contents of the manual.

2. USE OF THE EIGER R 1M

The EIGER R 1M detector system has been designed for the detection of X-rays produced by synchrotrons or laboratory sources. It is intended for indoor use only. For other applications, please contact DECTRIS technical support for additional information.

Caution

#2



Improper use of the DECTRIS detector system can compromise its safety and its functionality is no longer guaranteed.

Caution

#3



When using the detector in vacuum strictly follow the in-vacuum instructions given in this document.

2.1. Product Return and Recycling

We recycle DECTRIS detector systems that are no longer suitable for use. If you are not using your DECTRIS detector system any more, send it back to us. We will make sure that your system is responsibly and safely recycled. This is free for customers who purchased a new DECTRIS detector system.

3. TECHNICAL SPECIFICATIONS

3.1. Specifications

3.1.1. Quantum Efficiency

Table 3.1: Quantum Efficiency

Sensor thickness		450 μm
Quantum efficiency	at 5.4 keV (Cr):	94 %
	at 8.0 keV (Cu):	98 %
	at 17.5 keV (Mo):	47 %

3.1.2. Detector

Table 3.2: Technical Specifications

Number of modules (W x H)		1 x 2 = 2
Sensor		Reverse-biased silicon diode array
Sensor material		Silicon (Si)
Sensor thickness		450 μm
Pixel size (W x H)		75 μm x 75 μm = 5625 μm^2
Module size (W x H)		77 mm x 38.6 mm = 2972.2 mm^2
Pixel array format (W x H)		1030 pixel x 1065 pixel = 1 096 950 pixel
Active Area (W x H)		79.9 mm x 77.2 mm = 6168.28 mm^2
Intermodule gap		hor. - pixel, vert. 37 pixel
Image bit depth		16 bit or 32 bit
Readout bit depth		12 bit
Maximum count rate		5×10^8 photons/s/ mm^2
Energy range		5 keV to 36 keV
Adjustable threshold range		2.7 keV to 18 keV
Number of thresholds		1
Readout time		continuous readout, 10.00 μs dead time, duty cycle >99 %

Table 3.2: Technical Specifications - continued

Maximum frame rate	10 Hz
Information #1	
 When using the external trigger or external enable mode, the detector will not acquire an image if the effective frame rate is above 10 Hz.	
Point-spread function	1 pixel (FWHM)
Connection to control unit	1 x 10GBase-T Ethernet
Power supply	External power supply unit
Data format (file writer)	HDF5 / NeXus
Software interface	HTTP REST interface (via network connection)
Dimensions (W x H x D)	114 mm x 133 mm x 240 mm
Weight	3.9 kg
Overvoltage category	II
Means of protection	I (External TreNew (SINPRO) power supply)
Pollution degree	II
Maximum operating altitude	2000 m a.s.l.

3.1.3. Power Supply Unit

Information #2	
 Please consult the user documentation of the TreNew (SINPRO) MPU130-105 power supply unit for details.	

Table 3.3: Power Supply Unit Specifications

Power supply unit	TreNew (SINPRO) MPU130-105 Switching power supply
-------------------	--

3.1.4. Detector Control Unit

Information	#3
-------------	----



Please consult the user documentation of the DELL PowerEdge R230 server for details.

Table 3.4: Detector Control Unit Specifications

Detector control unit	DELL PowerEdge R230 Rack-mounted (1U) server
-----------------------	---

3.1.5. Thermal Stabilization Unit

Information	#4
-------------	----



Please consult the user documentation of the SMC HEC 002-A5B thermal stabilization unit for details.

Table 3.5: Thermal Stabilization Unit Specifications

Thermal stabilization unit	SMC HEC 002-A5B Closed circuit air-water thermal stabilization unit
----------------------------	--

3.2. Ratings

3.2.1. Detector

Table 3.6: Power Ratings

Detector power input	+12V DC, 100 W
Fuse	10 A slow-blow fuse. Type: Schurter 5x20 mm, 10 A, 250 V AC Part No. 0034.3127
Warning #1	
Always replace fuses with the same type.	
Detector external trigger input	2.1 – 5.0 V high level 0.0 – 0.8 V low level
Caution #4	
Absolute maximum is 5V. Applying a higher voltage will damage the detector.	
External trigger input impedance	High Impedance GPIO Port Typically >1 MΩ
Detector trigger output	5V (max. current 100 mA)

3.2.2. Power Supply Unit

Information#5



Please consult the user documentation of the TreNew (SINPRO) MPU130-105 power supply unit for details.

Table 3.7: Power Supply Unit Ratings

Power supply unit power input	<p>Input 100 VAC to 240 VAC, 47 Hz to 63 Hz, 1.58 A to 0.64 A</p> <p>Output 12 VDC, max. 10.84 A, 130 W</p>
	<p>Caution #5</p> <p> Use only the included power supply.</p>
AC connector	IEC-320-C14 input inlet
Dimensions	89.5 mm x 49.3 mm x 188.0 mm
Weight	0.8 kg

3.2.3. Detector Control Unit

Information#6



Please consult the user documentation of the DELL PowerEdge R230 for details.

Table 3.8: Detector Control Unit Ratings

Detector control unit power input	1 x 100 VAC to 240 VAC, 50/60 Hz, 1 A to 3 A, 250 W (Platinum)
Dimensions (W x H x D)	434.0 mm x 42.8 mm x 495.0 mm
Weight	<10.6 kg
Chassis	1U

3.2.4. Thermal Stabilization Unit

Information#7



Please consult the user documentation of the SMC HEC 002-A5B thermal stabilization unit for details.

Caution#6



The maximum allowable coolant pressure is 3 bar.

Table 3.9: Thermal Stabilization Unit Ratings

	Value
Thermal stabilization unit power input	Single phase 100VAC to 240VAC, allowable voltage range $\pm 10\%$, 50/60 Hz, 8 A (100VAC) to 3 A (240 VAC)
Dimensions (W x H x D)	270 mm x 393 mm x 436 mm
Weight	17.5 kg
Typical flow	3 L min ⁻¹
Maximum operation pressure	3 bar

3.3. Ambient Conditions

Caution #7



The EIGER R 1M detector is equipped with a temperature and a humidity sensor. When either sensor detects that the operating conditions are not met, the detector will shut off. However, as the sensors may not prevent damage, temperature and humidity should be monitored to avoid breaching the operation limits.

Information #8



The relative humidity within the module chamber must be lower than 30 % during operation and lower than 25 % during start up (use of dry air or nitrogen advised).

The EIGER R 1M detector is designed for indoor use only. The ambient conditions shown in table 3.10 must be satisfied. The stated values are for the ambient conditions. Values inside the detector, in particular due to the dry-air or nitrogen supply, are different. These are described in section 5.4 and chapter 6.

Table 3.10: Detector Operating Ambient Conditions

Ambient Condition	Value
Operating temperature	+20 °C to +35 °C
Operating humidity	<80 % at 20 °C, non-condensing
Storage temperature	+15 °C to +40 °C
Storage humidity	<40 % at 20 °C, non-condensing

Caution #8



Please consider following points when storing the detector

- Make sure the temperature and the humidity inside the transport box does not exceed the specified range (use of a drying agent is required).
- Ensure that no condensation moisture develops if the detector is stored at low temperature.

4. DETECTOR DIMENSIONS AND CONNECTORS

4.1. EIGER R 1M Detector

4.1.1. Technical Drawing

Information #9



3D step files of the EIGER R 1M detector are available on request. Please contact DECTRIS technical support for more information.

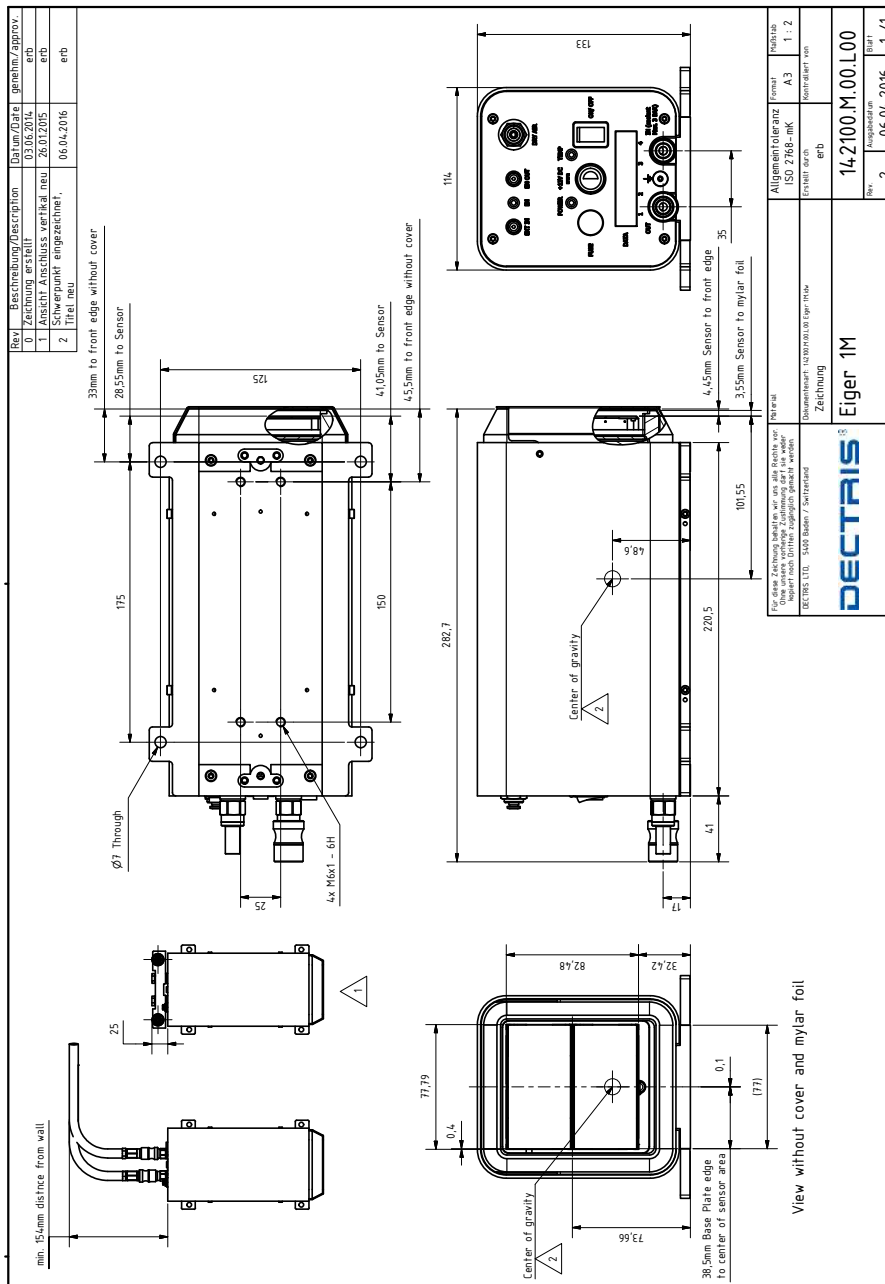

Figure 4.1: Drawing of the EIGER R 1M Detector (also printed separately in the user documentation folder)

4.1.2. Front Side of the Detector



Danger	#1
<p> Danger of electric shock. Do not touch the Mylar® foil. The sensors behind the Mylar® foil are operated at high voltages. Touching the Mylar® foil can cause an electrical shock.</p>	
Warning	#2
<p> Do not touch the Mylar® foil to avoid damage of the sensors.</p>	
Caution	#9
<p> The cover may not protect the detector from a direct beam.</p>	



Figure 4.2: The EIGER R 1M Detector with the Cover in Place (front view)

The detector comes with a protective cover (1.5 mm, Aluminium) for the front window, which should only be removed during operation. The sensors are behind a 12 µm thick Mylar® (PET) foil coated with aluminum to protect them from humidity, dust and from being touched.



Figure 4.3: The EIGER R 1M Detector with the Cover Removed (front view)

4.1.3. Back Side of the Detector



Figure 4.4: The EIGER R 1M Detector (back view)

4.1.4. Status LEDs

Table 4.1: The Meaning of the Status LEDs on the Detector Back Plane

LED	Description
LINK	Glowing green if detector and DCU are powered and connected via the RJ45 data cable.
ACT	Flashing green if there is activity on the data line between detector and DCU.
EN	Orange/Yellow to indicate the detector is in counting mode, but is otherwise switched off.
TEMP	Red at power-on, when the detector is not initialized, or if the detector temperature or humidity is out of the limits. Turns green on detector initialization if temperature and humidity are within the allowed limits.
POWER	Green when the power supply is functioning. Red is an indication of power failure or if the detector temperature or humidity is out of the operating limits.

4.1.5. Connectors and Connecting Cables/Pipes

Table 4.2: Electric Connectors and Connecting Cables

Connector	Description
DATA	<p>1 x RJ45 Ethernet connector DATA 1 -> detector control unit port 1</p> <p>Use Cat 6A S/FTP Ethernet cable(s).</p> <div style="background-color: yellow; padding: 5px; display: flex; justify-content: space-between;"> Caution #10 </div> <p> There must be a 1 x 10GBase-T Ethernet point-to-point connection between detector and detector control unit.</p>
POWER	DC power connector (see tables 3.6 and 3.7)
EXT IN	<p>External trigger input (see table 3.6) Use a Lemo[®] Type 00 (NIM/CAMAC) cable.</p>
EN OUT	<p>Output signal 5V (max. current 100 mA) (see table 3.6) High when counting is enabled. Use a Lemo[®] Type 00 (NIM/CAMAC) cable.</p>

Table 4.2: Electric Connectors and Connecting Cables - continued





Connector	Description				
	Functional ground				
	<table border="1"> <thead> <tr> <th>Information</th> <th>#10</th> </tr> </thead> <tbody> <tr> <td></td> <td>Although the detector might be already grounded via the mounting bolts, the detector should be grounded additionally via the functional ground connector at the back to establish a defined grounding.</td> </tr> </tbody> </table>	Information	#10		Although the detector might be already grounded via the mounting bolts, the detector should be grounded additionally via the functional ground connector at the back to establish a defined grounding.
Information	#10				
	Although the detector might be already grounded via the mounting bolts, the detector should be grounded additionally via the functional ground connector at the back to establish a defined grounding.				
FUSE	Fuse (see table 3.6)				

Table 4.3: Air Connectors

Connector	Description
DRY AIR	Dry air or nitrogen for humidity control. Use a hose/pipe with an outer diameter of 4 mm. To release the tube press and hold the blue ring before pulling at the tube.

Table 4.4: Coolant Connectors (see table 3.7)

Connector	Description
IN	Coolant inlet
OUT	Coolant outlet

Caution #11



Use only the included thermal stabilization unit.

4.2. Detector Control Unit

4.2.1. Configuration

Caution #12



Do not access or modify the operating system of the detector control unit.

The user interface of the detector control unit is accessible using a web browser. The detector control unit does not need any connections other than the power and Ethernet cables.

The detector control unit has to be connected point-to-point to the detector via 1 x 10GBase-T Ethernet. The detector control unit can be integrated into the site network infrastructure using one of the interfaces described in table 4.5. The detector control unit is optimised for performance and

stability of operation. In order to achieve these goals we deliver the detector control unit with fixed firmware (bios etc.) and software (OS) version. The detector control unit must not be operated in an environment where unauthorized access is possible. The detector control unit does not provide authentication mechanisms and is not protected against malicious acts by unauthorized third parties.

Using the web front end, it is possible to restart the EIGER control service, trigger an update, and to shut down and to reboot the detector control unit. Any further control of the detector is carried out via the SIMPLON API (see separate documentation).

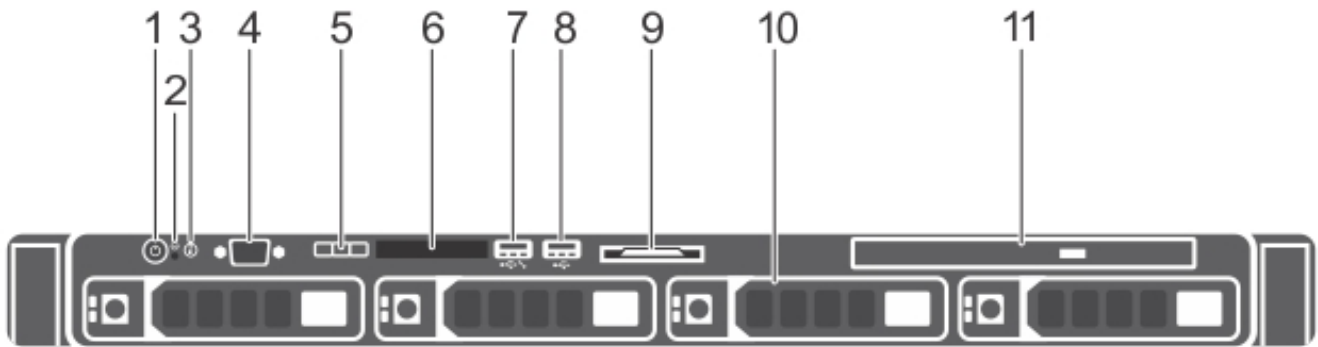

Figure 4.5: EIGER R 1M detector control unit as seen from the front.

1: Power button and LED; 9: DELL Service Tag; 11: DVD drive for firmware upgrade; other numbered items are not relevant for operation of the detector system.

Caution #13



Pushing the power button on the front panel longer than 2 seconds will immediately halt the detector control unit. All image data on the detector control unit will be permanently lost.

Information #11



Briefly pushing the power button on the front panel will shut down the detector control unit. May take up to 1 min.

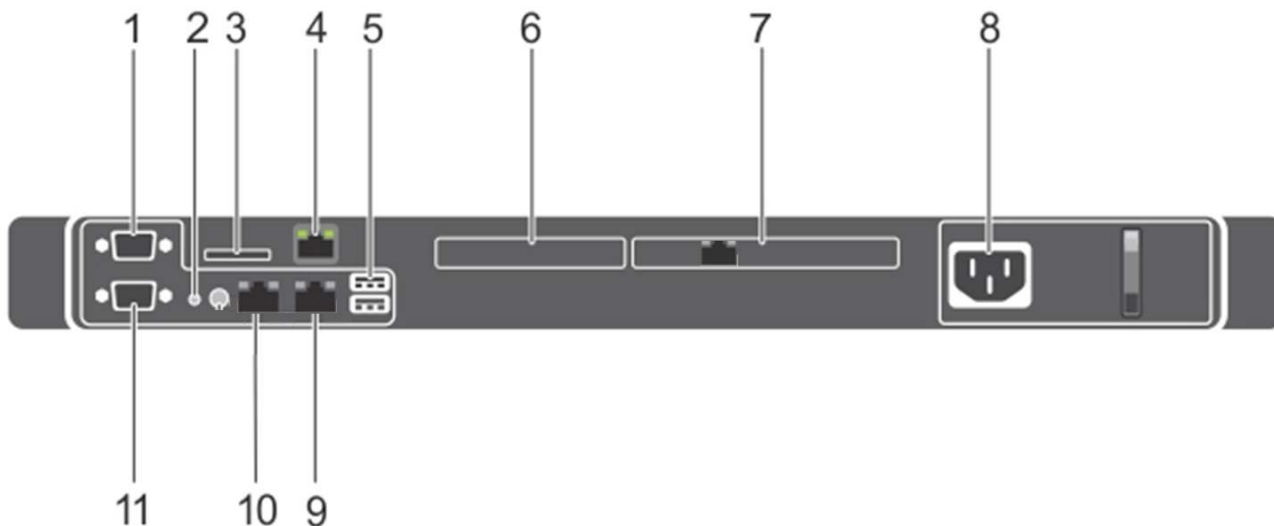

Figure 4.6: EIGER R 1M detector control unit as seen from the back. Numbered items relevant for operation of the detector system are described below.

4.2.2. Connectors

Table 4.5: Detector Control Unit Connectors

Connector	Description
EM1 (Embedded, figure 4.6 (10))	Interface Name: EM1 (1 GBase-T) User configurable GbE Network Interface Preconfiguration: DHCP
EM2 (Embedded, figure 4.6 (9))	Interface Name: EM2 (1 GBase-T) Fallback GbE Network Interface Preconfiguration: Static 10.42.41.10 (Netmask 255.255.255.0)
P2P1 (Slot 1, figure 4.6 (7))	10GBase-T Ethernet Detector Interface Port1
Power (figure 4.6 (8))	AC Connector

See DELL owner’s manual for further details.







4.3. Thermal Stabilization Unit

A thermal stabilization unit is required for the operation of the EIGER R 1M detector system. The hoses and the detector are equipped with self-sealing valves to avoid dripping when connecting or disconnecting the tubes. There is no fixed limitation on the length of the tubing, but it should be kept as short as possible to ensure the best flow.

Table 4.6: Operating Conditions

Condition	Definition
Operating temperature	The thermal stabilization unit has to be set to a temperature of 23 °C for normal operation.
Maximum operating pressure	3 bar

Table 4.6: Operating Conditions - continued

Condition	Definition
Coolant	66 % distilled water and 34 % ethylene glycol.
<div style="background-color: red; color: white; padding: 5px; display: inline-block;">Danger #2</div>	
<div style="display: flex; align-items: flex-start;"> <div style="margin-right: 10px;"></div> <p>Ethylene glycol can be seriously harmful to your health or fatal if handled incorrectly. Consider the packaging and safety instructions provided by your local supplier.</p> </div>	
<div style="background-color: #0056b3; color: white; padding: 5px; display: inline-block;">Information #12</div>	
<div style="display: flex; align-items: flex-start;"> <div style="margin-right: 10px;"></div> <p>Before operating the thermal stabilization unit, please read the User Manual of the thermal stabilization unit.</p> </div>	
<div style="background-color: yellow; padding: 5px; display: inline-block;">Caution #14</div>	
<div style="display: flex; align-items: flex-start;"> <div style="margin-right: 10px;"></div> <p>When connecting or disconnecting the cooling hoses, turn off the detector and the thermal stabilization unit.</p> </div>	
<div style="background-color: yellow; padding: 5px; display: inline-block;">Caution #15</div>	
<div style="display: flex; align-items: flex-start;"> <div style="margin-right: 10px;"></div> <p>When operating the detector, the thermal stabilization unit must always be turned on and the pump has to be activated (see user documentation of thermal stabilization unit).</p> </div>	
<div style="background-color: yellow; padding: 5px; display: inline-block;">Caution #16</div>	
<div style="display: flex; align-items: flex-start;"> <div style="margin-right: 10px;"></div> <p>Use opaque hoses to avoid the growth of algae.</p> </div>	
<div style="background-color: yellow; padding: 5px; display: inline-block;">Caution #17</div>	
<div style="display: flex; align-items: flex-start;"> <div style="margin-right: 10px;"></div> <p>Do not set the temperature of the thermal stabilization unit below the recommended operating temperature. Condensing moisture can develop and damage the detector.</p> </div>	

4.3.1. In-Vacuum Operation

For in-vacuum operation unscrew the self-sealing valves from the detector and use vacuum-compatible fittings and o-rings. Before opening the cooling circuit always remove the coolant to avoid dripping.

Table 4.7: In-Vacuum Operating Conditions

Condition	Definition
Operating temperature	<p>Before and during pumping down and venting the thermal stabilization unit has to be set to a temperature of 23 °C for at least 30 min.</p> <p>Prior to powering up and operating the detector in-vacuum the thermal stabilization unit has to be set to a temperature of 15 °C for at least 30 min.</p>

5. INSTALLING THE DETECTOR SYSTEM

5.1. Transport Considerations

Warning

#3



Avoid vibration and shock when moving the detector.

Caution

#18



Use the included lifting eye for transporting the detector where applicable.

The detector has been delivered in a robust transport box. Please keep this transport box for transport or storage purpose.

5.2. Mounting

The detector can be mounted in the ways which are described below.

5.2.1. Mounting from Above

Use the mounting brackets¹ as depicted in figure 5.1. These mounting brackets have to be mounted on the base plate of the detector. The detector should be mounted using all four outer 7 mm holes (indicated with yellow circles).

Caution

#19



Make sure the mounting brackets are mounted and properly tightened using the screws provided. The placement of the screws is indicated with yellow diamonds in figure 5.1.

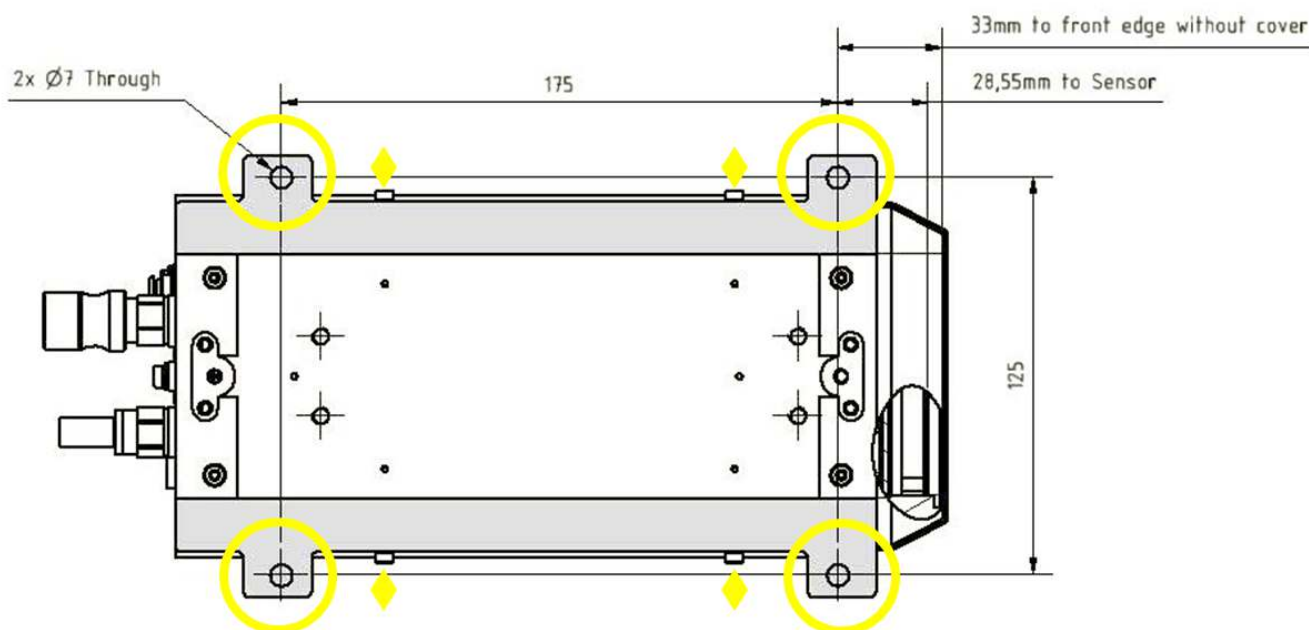

Figure 5.1: Drawing of the EIGER R 1M Detector Base Plate with Mounting Brackets (bottom view)

¹ Optionally available.

5.2.2. Mounting from Below

Warning #4



It is strictly forbidden to add any threads to the detector base plate or to the detector housing.

The detector should be mounted using the four internal M6x1 threads as shown in figure 5.2 (indicated with yellow circles).

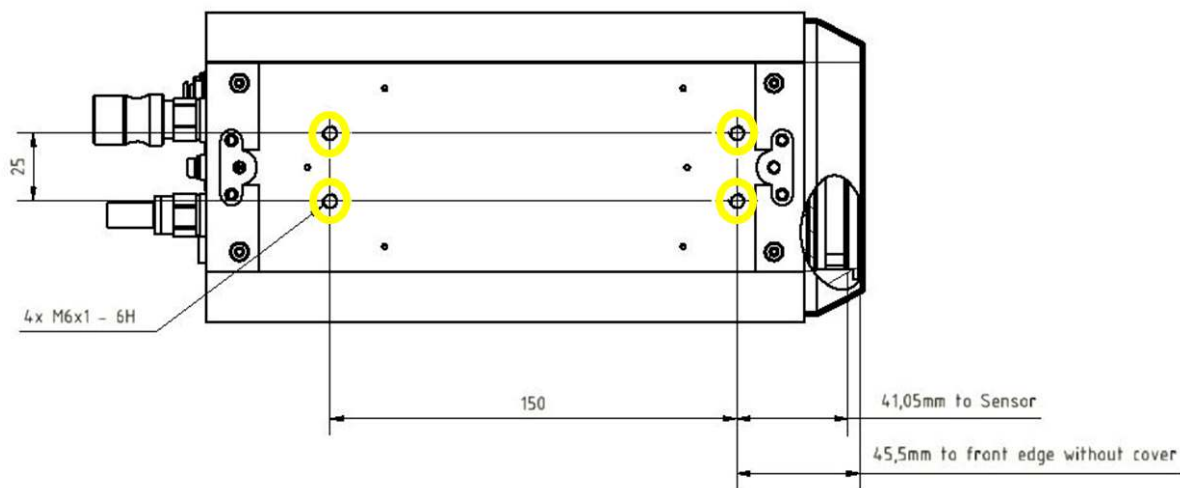

Figure 5.2: Drawing of the EIGER R 1M Detector Base Plate (also printed separately in the user documentation folder)

Caution #20



The four M6 screws must not intrude into the detector more than 10 mm.

5.3. Grounding of the Detector

Caution #21



The main plug of the detector control unit and the power supply of the detector have to be connected to a grounded power outlet.

Although the detector might be already grounded via the mounting bolts, the detector should be grounded additionally via the functional ground connector at the back in order to establish a defined grounding.

5.4. Connection to Dry Air or Nitrogen

Warning

#5



When venting with nitrogen, take proper precaution against the risk of asphyxiation caused by oxygen displacement from nitrogen. Ensure sufficient ventilation and oxygen level monitoring. Use compressed air for venting large vessels or in confined spaces.

Caution

#22



Humidity might damage the detector. Make sure that the detector is operated within the allowed ambient conditions (see section 3.3).

The EIGER R 1M detector has to be connected to a dry air (or nitrogen) source to avoid humidity and condensation damage when it is outside of the storage box. For information on system connections, refer to the section 4.1.5 and for storage of the detector system refer to the section 7.5.

Information

#13



Oil free, dry air of <20 % relative humidity or nitrogen must be used.

- The recommended flow is 5 l h⁻¹ to 10 l h⁻¹ (at 2 bar).
- For reliable operation we recommend dry air of <5 % relative humidity.
- The gas pressure must not exceed 2 bar.
- The minimum gas pressure is 1 bar.
- The humidity control shuts down the power of the detector modules when the humidity is too high (see chapter 6).

5.4.1. In-Vacuum Use

Caution

#23



The temperature and humidity control cannot prevent condensation issues and resulting damage to the sensor due to improper use. Always make sure that the detector is warmed up (thermal stabilization unit temperature set to 23 °C) prior to pumping down, venting, and opening the chamber. Only use dry air or nitrogen for venting.

For in-vacuum operation no nitrogen or dry air flow is necessary.

5.5. Connection to Thermal Stabilization Unit

Caution

#24



- Use only the included thermal stabilization unit.
- Use only the supplied hose couplings.

The EIGER R 1M detector is water-cooled and must be connected to a dedicated thermal stabilization unit.

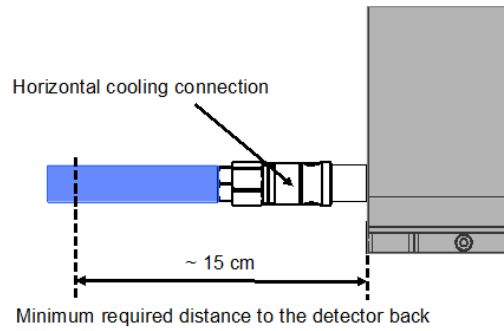

Figure 5.3: Horizontal coolant connectors

5.6. Mounting the Detector Control Unit

Caution

#25



Make sure that the detector control unit has adequate ventilation.

The detector control unit can be mounted in a standard 19 inch rack, which has to be properly grounded.

6. TEMPERATURE AND HUMIDITY CONTROL

The EIGER R 1M detector has a combined temperature and humidity sensor. The temperature and humidity control shuts down the detector when the humidity or the temperature of the sensor exceeds the following limits:

Table 6.1: Temperature and Humidity Limits

Shutdown Temperature		Shutdown Humidity
Lower Limit	Upper Limit	Upper Limit
15 °C	35 °C	30 % at operation / 25 % at start-up

The communication with the detector control unit will remain active after a temperature shut down (only power of the modules shuts down).

Warning #6



The temperature and humidity control cannot prevent condensation issues and resulting damage to the sensor due to improper use. Always make sure that the detector is warmed up (thermal stabilization unit temperature set to 23 °C) prior to pumping down, venting, and opening the chamber. Only use dry air or nitrogen for venting.

Information #14



The detector has an internal thermal protection switch. If the thermal protection switch is activated, it turns the detector off to prevent damage. In this case all LEDs will be off and no communication is possible any more with the detector. The detector will automatically power on again, as soon it is cooled down to appropriate working conditions.

Information #15



If the humidity is outside the specified range, the software will prevent operation and a respective error message will be raised by the API. The user can check the temperature and humidity via the API, as long as the temperature is not out of range. If the temperature breaches safe conditions the thermal protection switch will be triggered and the detector will completely switch off.

To start the detector correctly, please refer to section 7.1 and execute the correct startup procedure.

Make sure that the cooling unit is running at the recommended temperature (according to section 4.3) and that Nitrogen or dry air flow is turned on at the recommended flow rate, given in section 5.4. Then restart the software.

Information #16



A free-flowing air stream is mandatory in order to properly cool the electronics inside the detector. Do not cover any ventilation holes.

7. OPERATION PROCEDURE

Before operating the detector, make sure you have read the Technical Specifications and the User Manual.

7.1. Getting Started

Before switching on:

- Mount the detector properly.
- Connect the detector to ground potential, using the functional ground connector.
- Connect the detector to power supply; make sure the detector power switch is OFF.
- Connect the detector to a nitrogen or dry air source, capable of supplying at least the minimum recommended flow rate.
- Connect the coolant hoses. Make sure they are properly mounted on both sides.
- Set the temperature to 23 °C on the thermal stabilization unit and turn it on. If the detector was not at room temperature, wait until the thermal stabilization unit has reached stable operation.
- Connect the power cable, the local network cable, and the detector data cable to the detector control unit. (If more than one Ethernet cable is required, please pay attention to the numbering of the cables as described in table 4.2)

7.2. Startup Procedure

Please use the following startup procedure:

- Turn on the dry air or nitrogen at least 30 min before turning on the detector. Then turn ON the power switch at the back of the detector.
- Turn on the detector control unit. Wait at least 5 min before trying to connect.

The detector should now be ready to use.

Information

#17



The software start-up procedure is described in detail in the User Manual.

7.3. Turning Off the Detector

To turn off the detector:

- Turn OFF the detector power switch.
- Turn OFF the detector control unit.
- Do not remove the nitrogen/dry air connection. It is a requirement that it is left at the recommended flow rate according to section 5.4.

7.4. Vacuum Operation

DECTRIS detectors can be provided for vacuum operation. The typical reachable vacuum is 10^{-3} mbar (read-out electronics in vacuum) or 10^{-6} mbar (only detector head in vacuum). The outgassing rate and content are not specified. The vacuum compatibility option guarantees that the detector will operate in the mentioned vacuum range. Detectors ordered with a vacuum compatibility option have been tested in vacuum.

To see if a detector is vacuum compatible, check whether the vacuum compatibility option is included in the order confirmation received from DECTRIS.

7.4.1. Ambient Conditions for In-Vacuum Use

Warning #7



Only systems with a vacuum compatibility option are allowed to be operated in vacuum. Please contact support@dectris.com for information regarding vacuum compatibility upgrade.

For in-vacuum operation of the detector following conditions must be fulfilled:

Table 7.1: In-Vacuum Operating Conditions

In-Vacuum Condition	Definition
Pressure during operation	atmospheric pressure or less than 0.01 mbar
Detector mounting plate temperature during operation	10 °C to 25 °C
Thermal stabilization unit set temperature in vacuum	15 °C
Chamber temperature during "bake-out" (detector unpowered)	max. +60 °C (for temperatures > 40 °C make sure the thermal stabilization unit is set to +40 °C and running)

7.4.2. Operation Procedure In-Vacuum

Make sure the vacuum conditions in table 7.1 are met and follow below procedures for venting and pumping down the vacuum chamber.

Warning #8



Prior to pumping down (and venting): Always make sure the detector is SWITCHED OFF and WARMED UP to room temperature. Otherwise it could be damaged through electrical discharge or condensation.

Pumping Down the Vacuum Chamber

- Mount the detector properly inside the vacuum chamber.
- Connect the detector power, data, trigger, and coolant lines inside and outside the vacuum chamber.
- Connect the detector control unit and the detector data cables.
- Make sure the power switch on the back of the detector is ON and the power switch on the detector power supply is OFF (i.e. the detector can be powered up later from outside the vacuum chamber).
- Close the vacuum chamber and start to pump down.
- Once the pressure inside the vacuum chamber is below 1×10^{-2} mbar set the temperature on the thermal stabilization unit to 15 °C and turn on the thermal stabilization unit (pumping down a warm detector prevents condensation issues).
- After the thermal stabilization unit has reached the set value, switch on the external power supply unit.

Venting the Vacuum Chamber

- Turn OFF the power switch on the detector power supply.
- Set the temperature to 23 °C on the thermal stabilization unit and let the detector warm up at least 30 min to prevent condensation inside the vacuum chamber.
- Use dry air or nitrogen to vent the chamber.

7.5. Storing the Detector

Information

#18



Even if the detector is not in operation, it is recommended that the dry air or nitrogen flow is maintained to reduce the risk of humidity damage to the detector.

Please follow these instructions:

- Put the detector in a plastic bag, add at least 200g of drying agent (i.e. silica gel) into the bag and seal it air-tight.
- Check the humidity and change the drying agent frequently for compliance with the storage requirements in section 3.3.

7.6. Cleaning and Maintenance

Caution

#26



The Mylar[®] foil must not be touched or cleaned. If it becomes dirty or is damaged, please contact DECTRIS technical support.

The housing can be cleaned with a soft tissue.

The EIGER R 1M detector does not require any maintenance.

Please refer to the user documentation of the thermal stabilization unit for detailed information about the maintenance of your thermal stabilization unit.

8. TROUBLESHOOTING

table 8.1 provides an overview of possible problems with the detector system and instructions in order to solve the problems. If the problem you are experiencing is not listed below or if the instructions do not help, please contact support@dectris.com.

Table 8.1: Troubleshooting

Problem	Cause	Solution
Detector control unit does not start properly.	Detector control unit is not powered.	Check the User Documentation of the detector control unit (see section 3.1.4).
Communication error, the detector is not found at startup.	Data cable is not connected or defective.	<p>Check the connection between detector control unit and detector. Make sure that there is a direct, peer-to-peer connection between the detector control unit and the detector.</p> <p>Avoid tangling or strong bending of the Ethernet data cable.</p> <p>Check the status of the LINK LED. If the detector control unit and the detector are powered and correctly connected, the LINK LED should be green (Takes up to 30s after power up).</p>
The detector fails to turn on.	The power cord is not connected or the plug is incompletely inserted.	Connect the power cord firmly. Check the green LED on the external power supply.
	The fuse is blown.	Replace the fuse, see section 4.1.5.
	The temperature is over the critical limit. The thermal protection was triggered.	Check the thermal stabilization unit. The detector will power on again, as soon as the temperature is within the allowed operating conditions.
Image acquisition not possible.	Detector is not properly initialized.	Check the status of the POWER LED. If it is red and the TEMP LED is green, there is a problem with the electronics – contact support@dectris.com .
Detector housing is humid.	Ambient humidity around the detector exceeds the operating conditions.	Shut down the detector immediately and check the humidity. Power up the detector only when the ambient humidity has been reduced.